

AC INFINITY

PROPAGATION SYSTEM

HUMIDITY CONTROLLED ENVIRONMENT

USER MANUAL

SAMSUNG
HORTICULTURE LED



illuminated

Plant-centric
Spectrum

EVO

WELCOME

Thank you for choosing AC Infinity. We are committed to product quality and friendly customer service. If you have any questions or suggestions, please don't hesitate to [contact](#) us. Visit www.acinfinity.com and click contact for our contact information.

EMAIL

support@acinfinity.com

WEB

www.acinfinity.com

LOCATION

Los Angeles, CA

MANUAL CODE HD2305X1

PRODUCT

Humidity Dome, Medium Heavy-Duty
Heated Humidity Dome, Medium Heavy-Duty
Propagation Kit, Medium Heavy-Duty
Propagation System, Medium Heavy-Duty
Humidity Dome, Large 1020
Propagation Kit, Large 1020
Propagation System, Large 1020

MODEL

AC-HDA5
AC-HDM5
AC-HDL5
AC-HMX5
AC-HDA7
AC-HDL7
AC-HMX7

UPC-A

819137023208
819137023420
819137023215
819137023413
819137023864
819137023871
819137023888

MANUAL INDEX

Manual Index	Page 5
Product Warning	Page 6
Key Features	Page 7
Product Contents	Page 9
Installation: SUNCORE Seedling Mat	Page 10
Installation: Humidity Dome	Page 11
Installation: IONBEAM LED Light Bars	Page 13
Powering and Setup.....	Page 15
Controller Mounting	Page 16
Starter Guide	Page 20
UIS™ Platform	Page 26
Cleaning	Page 27
Programming	Page 29
Other Settings	Page 35
Other AC Infinity Products	Page 36
Warranty	Page 37

PRODUCT WARNING



TO REDUCE THE RISK OF FIRE, ELECTRIC SHOCK, OR INJURY TO PERSONS, OBSERVE THE FOLLOWING:

1. Ensure your power source conforms to the electrical requirements of this product.
2. Read all instructions before installing and using this product.
3. Be careful not to damage or cut the wire insulation (covering) during the installation. Do not permit wires to come in contact with any sharp edges.
4. If you are unfamiliar or have doubts about performing this product's installation, seek the services of a qualified, trained, and licensed professional. Inappropriate installation will void this product's warranty.
5. This product must not be used in potentially hazardous locations such as flammable, explosive, chemical-laden or wet atmospheres.
6. Do not cover power cords or seedling mat with rugs or other fabric materials.
7. Safety precautions should be exercised during the installation, operation, and maintenance of this product.
8. Do not block or tamper with this product in any manner while it is in operation as it may cause electric shock, fire, or damage to this product.
9. Do not depend on the on/off programming as the sole means of shutting power from this product. Unplug the power cord before installing, servicing, or moving this product.
10. Do not operate this product while its cord is damaged, or if it malfunctions, has been dropped, or is damaged in any manner.

KEY FEATURES

MEDIUM HEAVY-DUTY SERIES

LOCKED-IN HUMIDITY

Dual built-in rotating vents provide precise control to lock in moisture or lower internal humidity levels.

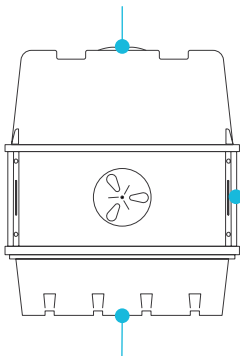

HEAVY-DUTY BUILD

Long-lasting tray with a 5x8 cell grid design that supports up to 40 seedlings and drains excess water.

SAMSUNG LED LIGHTING*

Two light bars with commercial-grade Samsung LM301H EVO diodes deliver full-spectrum lighting for greater growth rates.

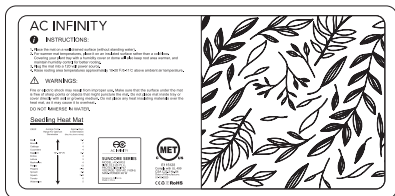
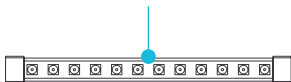

CLONE-FRIENDLY

Transparent vented dome extender heightens ceiling for taller plants in clone propagation applications.

DIGITAL CONTROLLER*

Smart controls feature SCHEDULE and SUNSET/RISE modes to activate ten light intensity levels.

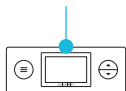

TEMPERATURE CONTROL*

Built-in dial controller gradually adjusts the far infrared film for uniform heating output in low, medium, and high settings.

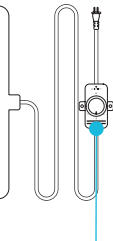

*Included only in select models

SAMSUNG
HORTICULTURE LED



illuminated

Plant-centric
Spectrum

EVO

KEY FEATURES

LARGE 1020 SERIES

LOCKED-IN HUMIDITY

Dual built-in rotating vents provide precise control to lock in moisture or lower internal humidity levels.

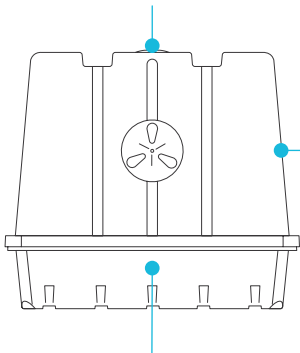

HEAVY-DUTY BUILD

Long-lasting tray with 6x12 cell grid supports up to 72 seedlings and drain excess water.

SAMSUNG LED LIGHTING*

Two light bars with commercial-grade Samsung LM301H EVO diodes deliver full-spectrum lighting for greater growth rates.

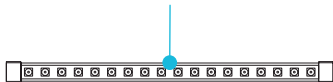

DIGITAL CONTROLLER*

Smart controls feature SCHEDULE and SUNSET/RISE modes to activate ten light intensity levels.

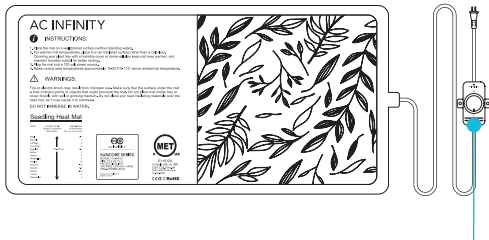
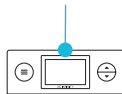

CLONE-FRIENDLY

Transparent dome with adjustable vents heightens ceiling for taller plants in clone propagation applications.

TEMPERATURE CONTROL*

Built-in dial controller gradually adjusts the far infrared film for uniform heating output in low, medium, and high settings.

*Included only in select models



Plant-centric
Spectrum

EVO

PRODUCT CONTENTS

HUMIDITY DOME



HUMIDITY
DOME
(x1)

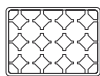

BASE
TRAY
(x1)

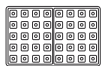

SEEDLING
TRAY
(x1)



VENT
DISKS
(x4)

HEAVY-DUTY MODELS ONLY



VENTED
PANEL
(x2)



SIDE
PANEL
(x2)



BOLT AND
WING NUTS
(x8)

IONBEAM LED LIGHT BARS (AC-HDL5V2, AC-HMX5V2, AC-HDL7V2, AC-HMX7V2)



LIGHT BAR
(SINGLE-CORDED)
(x1)



LIGHT BAR
(DUAL-CORDED)
(x1)



EC POWER
ADAPTER
(x1)



SCHEDULE
CONTROLLER
(x1)

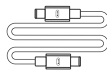

UIS EXTENSION
CORD (M-M)
(x1)



WIRE
MOUNT
(x1)



HOOK AND LOOP
CABLE TIES
(x4)



CONTROLLER
PLATE BOLTS
(x2)



HEX
NUTS
(x3)



WOOD SCREWS
(WALL MOUNT)
(x2)

SUNCORE SEEDLING MATS (AC-HDM5, AC-HMX5V2, AC-HMX7V2)



SEEDLING
MAT
(x1)



CONTROLLER
SCREW SET
(x2)

INSTALLATION

SUNCORE SEEDLING MAT

STEP 1

Unroll the seedling mat flat on to the ground.

Do not allow the mat to overlap onto itself.

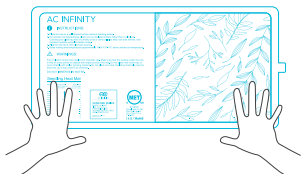

STEP 2

Connect the AC power plug to a power outlet to turn on the seedling mat.

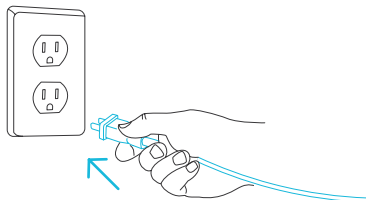

Included in AC-HDM5, AC-HMX5V2, and AC-HMX7V2 models.

INSTALLATION

HUMIDITY DOME

STEP 1

Place the seedling tray into the base tray.

For Large 1020 Series humidity domes, proceed to step 3.

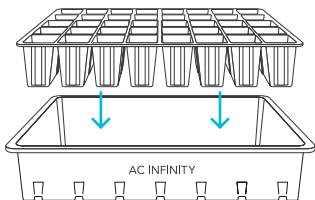

STEP 2

Assemble the dome extender*, keeping the vented panels on opposite ends and applying the plastic screw and nuts to secure the corners.

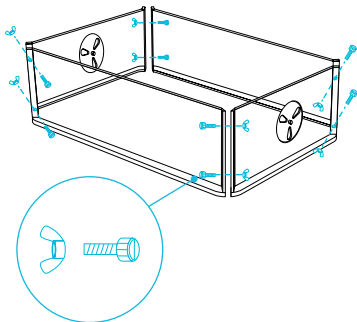

*Not included in Large 1020 models.

INSTALLATION

HUMIDITY DOME

STEP 3

Snap the vent disks into the side openings.

Adjust the vents as needed.

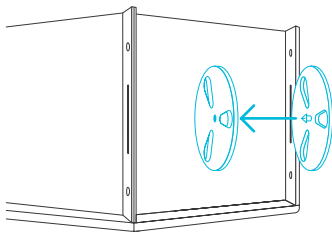

STEP 4

Place the dome over the tray.

You may also place the dome extender* in between the tray and dome as an option.

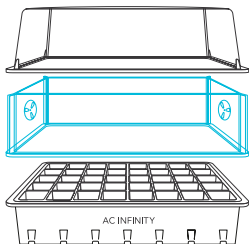

*Not included in Large 1020 models.

INSTALLATION

IONBEAM LED LIGHT BARS

STEP 1

Assemble the light bar chain.

- A. Connect the single-corded LED light bar's female port to the dual-corded LED light bar's male connector.
- B. Connect the power adapter's male connector to the other end of the dual-corded LED light bar.
- C. Connect the power adapter to the schedule controller using the included UIS M-M extension cord.

Secure all connections using the twist-on pieces.

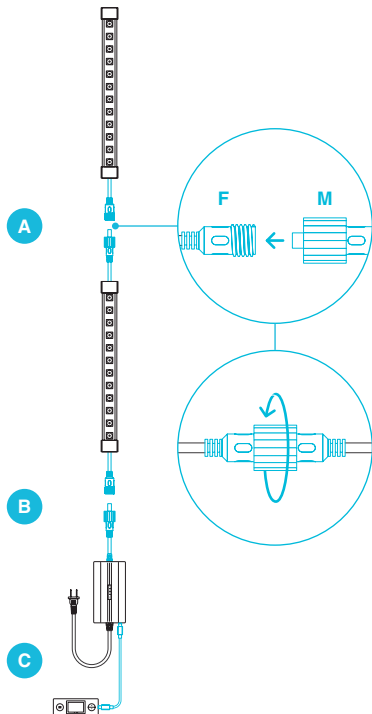

Included in AC-HDL5V2, AC-HMX5V2, AC-HDL7V2, and AC-HMX7V2 models.

INSTALLATION

IONBEAM LED LIGHT BARS

STEP 2

Place the LED light bars on top of the dome. Its diodes should fit snugly into the divots of the dome.

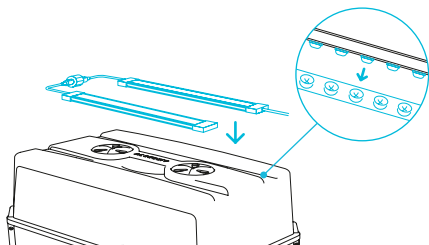

POWERING AND SETUP

IONBEAM LED LIGHT BARS

STEP 1

Use the included UIS M-M extension cord to connect the fan's EC Motor box to one of the controller's ports.

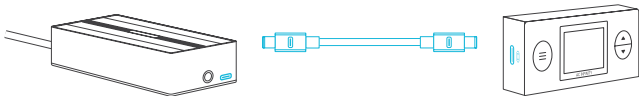

STEP 2

Plug the power adapter into a wall outlet.

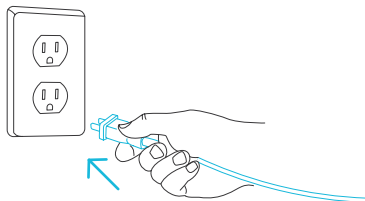

CONTROLLER MOUNTING

SUNCORE SEEDLING MAT

STEP 1

Use the dial controller to set your desired position. Mark the two mounting holes.

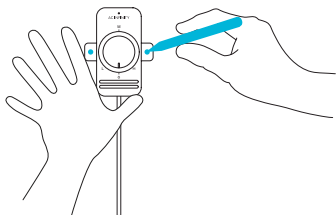

STEP 2

Drill two holes into the marked locations. Make sure your mounting area is structurally sound and free from obstruction.



CONTROLLER MOUNTING

SUNCORE SEEDLING MAT

STEP 3

Align the controller mounting holes with the markings. Using a screwdriver or drill, secure the controller to the marked locations with the included wood screws or machine screws with nuts.

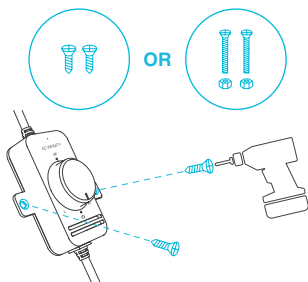

CONTROLLER MOUNTING

IONBEAM LED LIGHT BARS

STEP 1 — WALL MOUNTING

Locate a spot free of obstruction and secure the anchor into your wall. Twist the wood screw into the anchors.

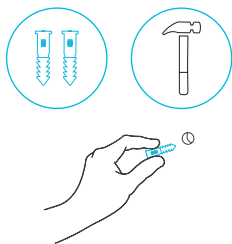

STEP 2 — WALL MOUNTING

Hang the controller by the screw using the holes on the backside.

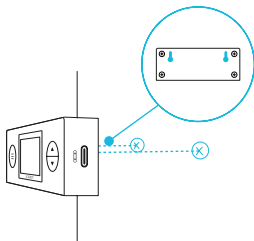

CONTROLLER MOUNTING

IONBEAM LED LIGHT BARS

MAGNET MOUNTING

The controller will magnetically mount onto the CLOUDLAB series advance grow tent's controller mounting plate* or any steel surface.

The magnet is located under the controller's label.

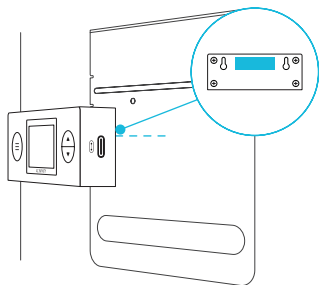
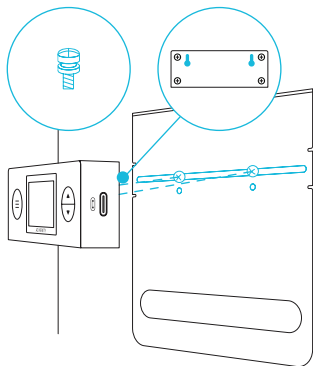

PLATE MOUNTING*

Screw the controller plate bolts into the slot or mounting holes at the upper half of the plate.

Hang the controller by the bolts using the holes on the backside.



*Controller plate not included

STARTER GUIDE

HUMIDITY DOME AND SEEDLING MAT

GROWING SEASONS

You may use a seedling mat to get a head start on the gardening season. Start the germination process during late winter or spring if you live in a colder region.

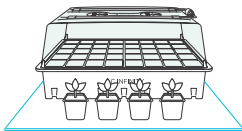

GERMINATION

Different seeds require different temperatures to germinate. Before you begin, refer to your seed package and the table on the seedling mat for recommended temperature settings.

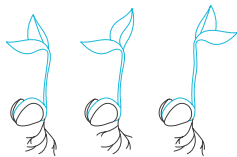

TEMPERATURE

If your seed packet does not specify a temperature, keep the temperature between 65°F and 75°F (18-24°C).

Make sure to also keep track of ambient room temperatures; along with your local weather, this can also affect your germination process.

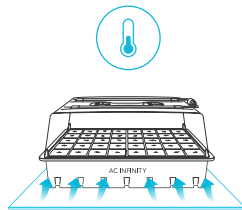

STARTER GUIDE

HUMIDITY DOME AND SEEDLING MAT

HUMIDITY

Closing the vents of the humidity dome will increase the humidity of the environment. To accelerate the environmental humidity build-up, pair the humidity dome with a seedling mat.

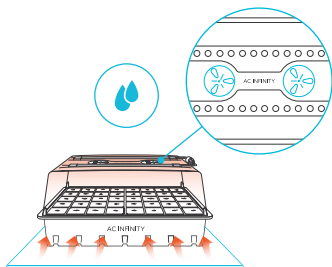

SOWING SEEDS

Sow 2-3 seeds per cell; not every seed will germinate. Cover the seeds completely with your grow media. Set the humidity dome over the tray. Place the seed tray on the seedling mat and turn it on to begin heating.

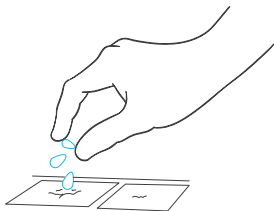

STARTER GUIDE

HUMIDITY DOME AND SEEDLING MAT

WATERING

Water your seed tray's starter mix or pellets, which will appear dark brown. Dry off any excess water.

Place the humidity dome on the seed tray and close all air vents. Lightly water your seeds whenever the mix/pellets appear light brown.

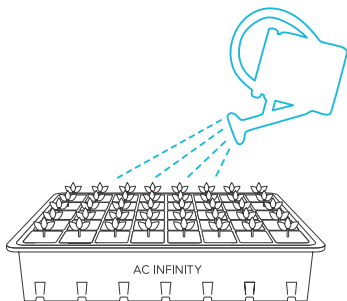

Once your seeds begin to germinate, open an air vent on the humidity dome. When about half of your tray yields seedlings, open two of the air vents on the humidity dome.



STARTER GUIDE

FULL SPECTRUM LIGHTING

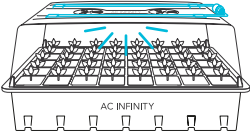

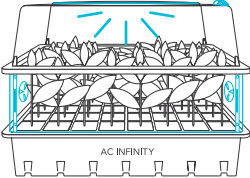
The chart below offers suggested mounting heights and light intensities for each stage in the growing process. These factors will vary based on the plant you are growing. Height refers to the minimum recommended distance from the canopy (tip of the plant) to the light.

GROW STAGE	Height	Intensity	Set-Up
Seedling Stage	1 IN.	<p>Level 1*</p>  <p>10% Brightness</p>	
Vegetative Stage	2 IN.	<p>Level 3</p>  <p>30% Brightness</p>	

*Also recommended for plant propagation.

STARTER GUIDE

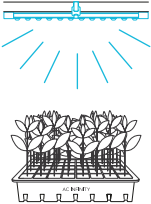
FULL SPECTRUM LIGHTING

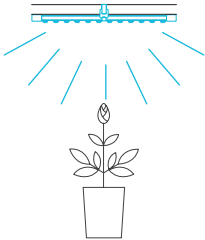
GROW STAGE	Height	Intensity	Set Up
Vegetative Stage	6 IN.	<p>Level 6</p>  <p>60% Brightness</p>	
Flowering Stage	6 IN.	<p>Level 10</p>  <p>100% Brightness</p>	

STARTER GUIDE

FULL SPECTRUM LIGHTING

SETTING ACTIVE LIGHTING TIMERS

The included controller can set daily schedules ranging from 1 minute to 24 hours.

Set a lighting schedule of 1-12 hours to extend your plant's daily exposure to light, in conjunction with natural sunlight, or when growing plants that don't require extended exposure.

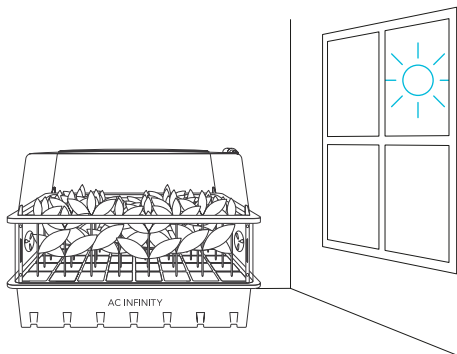

Set a lighting schedule of 12-24 hours to complement common light cycles used to grow high yield plants indoors. This will also allow for your device to sync with your grow set-up's existing lighting, so that they may activate at the same time.

UIS™ PLATFORM

The UIS™ platform enables you to connect a single central controller with several grow devices simultaneously. By creating this fully integrated system, you can power and program all your devices together or separately for optimized grow tent management.

Your grow system can be regulated using your controller hub or remotely on the AC Infinity app (paired with compatible controllers), where you will have access to automation programming and climate data.

You can also connect your favorite outlet device to integrate them into the UIS platform using our control plug module.

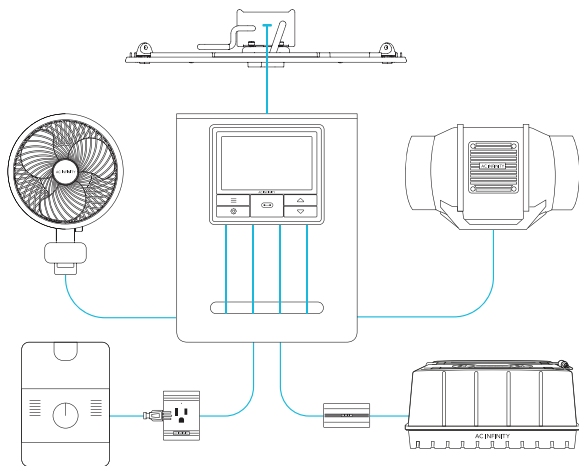

Central controller, mounting plate, and grow devices will be sold separately and may still be in development at the time of your purchase of this product.

CLEANING

STEP 1

Dip or soak a cloth with your preferred solvent.



STEP 2

Separate each section and wipe each item to clear them of any debris.

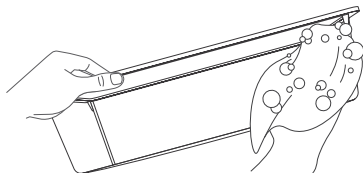

CLEANING

STEP 3

Using a dry cloth, pat or wipe each item and set them aside upside-down to dry.

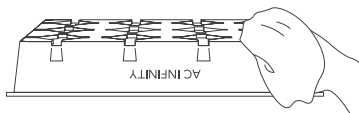

PROGRAMMING

HEATING CONTROLLER

LIGHT INDICATOR

When the controller is turned on and receiving power, the LED at the top of the controller will light up to show it is on.

ON

Turn the knob clockwise until you hear and feel a click to turn on the seedling mat.

OFF

Turn the knob counterclockwise from ON until you hear and feel a click to turn off the seedling mat.

SPEED CONTROL

Turning the knob will gradually adjust the heat between low, medium, and high.

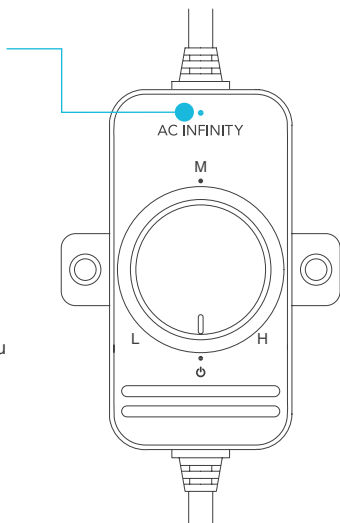

PROGRAMMING

SCHEDULE CONTROLLER

1. MODE BUTTON

Cycles through each of the controller modes: OFF, ON, SCHEDULE, SUNSET/RISE, and CLOCK. Holding this button will lock the controller; pressing this button afterwards will turn off the display.

2. UP/DOWN BUTTON

Adjusts the setting of your current mode.

3. CURRENT TIME

Displays the current time. The internal battery sustains the clock so it does not default to 00:00 if power is cut off.

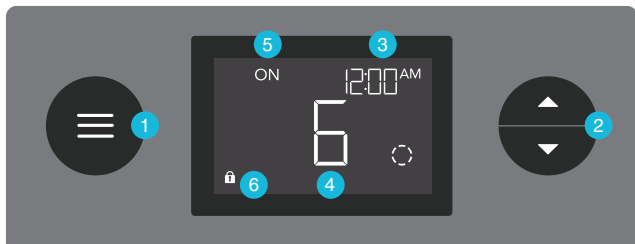

4. USER SETTING

Displays the grow light's intensity level as well as countdown timers of the Schedule modes.

5. CONTROLLER MODE

Displays the controller's current mode. Pressing the mode button cycles through the available modes.

6. LOCK ICON

Displays the controller lock status of the controller.

PROGRAMMING

SCHEDULE CONTROLLER

CONTROLLER MODES

Pressing the mode button will cycle through the controller's available programming modes and settings: OFF, ON, SCHEDULE, SUNSET/RISE, and CLOCK.

OFF MODE

Your grow light will not activate while in this mode. The intensity level set here establishes the minimum intensity level in the SCHEDULE mode. When it is triggered to turn off, it will instead shine at the level set here.

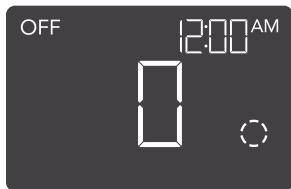

ON MODE

Your grow light will activate to the intensity level set here. The ON mode also serves as the maximum intensity level the SCHEDULE mode will shine in.

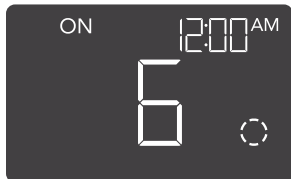

PROGRAMMING

SCHEDULE CONTROLLER

SCHEDULE MODE (ON & OFF)

Sets an on clock-time and an off clock-time schedule for your grow light to follow daily.

Press the up or down button to first set up an on clock-time to turn your grow light on, then press the mode button to set an off clock-time to turn your grow light off. Please be sure to set the current clock time under settings.

When your grow light turns on, it will run at your set maximum level. When your grow light turns off, it will run at your set minimum level.

The countdown will begin if no buttons are pressed for 5 seconds. Leaving the SCHEDULE mode while the countdown is running will pause it until you return to this mode.

Resetting the off clock-time will result in your grow light staying on until you actively turn it off.

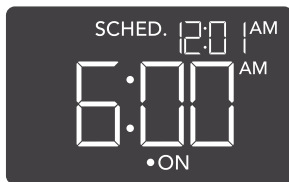

The grow light will shine at your set OFF mode level while it is off, and at your set ON mode level while it is on.

PROGRAMMING

SCHEDULE CONTROLLER

SUNSET/RISE SETTING

Sets a sunrise and sunset time for your grow light to brighten and dim, respectively. This setting only applies to SCHEDULE mode.

Press the up or down button to set a duration between 0:00 – 6:00 hours for your grow light to brighten and dim. For this setting to activate, you must return to SCHEDULE mode.

When your grow light is triggered to turn on, it will begin brightening up to your maximum level. It will then begin dimming down to your minimum level before it is triggered to turn off.

In this example, your grow light is set to turn on at 6:00 AM and turn off at 6:00 PM. The SUNSET/RISE setting is set to 2:00 hours. At 6:00 AM, your grow light will begin gradually brightening until it reaches your maximum level at 8:00 AM. Your grow light will then begin dimming at 4:00 PM until it reaches your minimum level at 6:00 PM.

You may deactivate this mode by setting the SUNSET/RISE timer to 0:00.

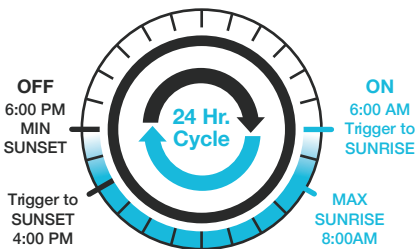

The grow light will shine at your set OFF mode level while it is off, and at your set ON mode level while it is on.

PROGRAMMING

SCHEDULE CONTROLLER

CLOCK MODE

Adjusts the current clock time. Use the up and down buttons to adjust the time. Once you cycle through 12:00 each time, the units will automatically change to AM or PM.

The clock time is located at the center of the display and the upper right hand corner.



TOGGLING THE DISPLAY

Lock the controller by holding the mode button.

Press the mode button to turn the display off. Pressing the mode button again will turn the display back on.

Programs will still run in the background while the LCD screen is off.



HOLD + 



PRESS + 

OTHER SETTINGS

SCHEDULE CONTROLLER

FACTORY RESET

Holding the mode and up/down buttons together for 5 seconds will reset your controller and restore factory settings. This will clear all user set parameters of each controller mode and setting.

HOLD +



RESET TO OFF/DEFAULT

Holding the up and down buttons together for 2 seconds will reset the value of your current mode to its default setting. In SCHEDULE mode, pressing the up or down button after resetting will return it to its previous value.

HOLD +



CONTROLLER LOCK

Holding the mode button will lock the controller in your current mode. While your controller is locked, no parameters may be adjusted nor will you be able to switch modes. Holding the mode button again will unlock the controller.

HOLD +



HIDE SCREEN

Lock the controller so no settings can be adjusted. See above. Then press the mode button to turn the display off. Pressing the mode button again will turn the display back on. Programs will still run in the background while the LCD screen is off.

PRESS +



AC INFINITY PRODUCTS

Advance Grow Tents

The CLOUDLAB series is a line of grow tents designed to create ideal growing conditions and facilitate indoor plant cultivation year-round. Features 2000D thick oxford canvas lined with inner diamond patterned mylar that maximizes grow light luminosity, and a reinforced frame with 150 lb. weight capacity. Includes a mounting plate to install your AC Infinity controller onto.

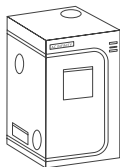

Fabric Pots

A set of gardening grow bags designed to create wider root networks and improve plant growth by air pruning roots while draining excess water. Features industry leading 500G thick nonwoven fabric sewn with metal rings to enable air-suspended hanging or twist tie pass-through for low stress plant training.

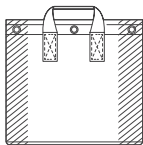

Inline Duct Fans

The CLOUDLINE series is a line of duct fans designed to quietly ventilate AV rooms and closets, as well as various DIY air circulation and exhaust projects. Features a thermal controller with intelligent programming that will automatically adjust duct fan speeds in response to changing temperatures.

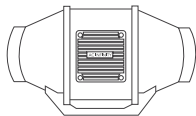

Discover the latest innovations in environmental controls at acinfinity.com

WARRANTY

This warranty program is our commitment to you, the product sold by AC Infinity will be free from defects in manufacturing for a period of two years from the date of purchase. If a product is found to have a defect in material or workmanship, we will take the appropriate actions defined in this warranty to resolve any issues.

The warranty program applies to any order, purchase, receipt, or use of any products sold by AC Infinity or our authorized dealerships. The program covers products that have become defective, malfunctioned, or expressly if the product becomes unusable. The warranty program goes into effect on the date of purchase. The program will expire two years from the date of purchase. If your product becomes defective during that period, AC Infinity will replace your product with a new one or issue you a full refund.

The warranty program does not cover abuse or misuse. This includes physical damage, submersion of the product in water, incorrect installation such as wrong voltage input, and misuse for any reason other than intended purposes. AC Infinity is not responsible for consequential loss or incidental damages of any nature caused by the product. We will not warrant damage from normal wear such as scratches and dings.

Contact our dealers department at dealers@acinfinity.com or (626) 838-4656 for more information about our dealers and distributors program. Contact our customer service department at support@acinfinity.com or 626-923-6399 for product and warranty assistance. Our business hours are Monday through Friday, 9:00 am to 5:00 pm PST.



If you have any issues with this product, contact us and we'll happily resolve your problem or issue a full refund!

COPYRIGHT © 2023 AC INFINITY INC. ALL RIGHTS RESERVED

No part of the materials including graphics or logos available in this booklet may be copied, photocopied, reproduced, translated or reduced to any electronic medium or machine readable form, in whole or in part, without specific permission from AC Infinity Inc.

www.acinfinity.com